

TKK 90	880-890	2000	695
TKK 100	980-990	2000	695

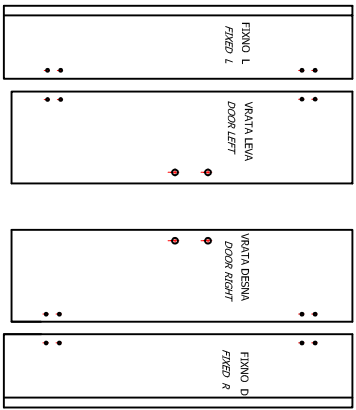

- 6 kom 4 x 10
- 8 kom 4 x 40

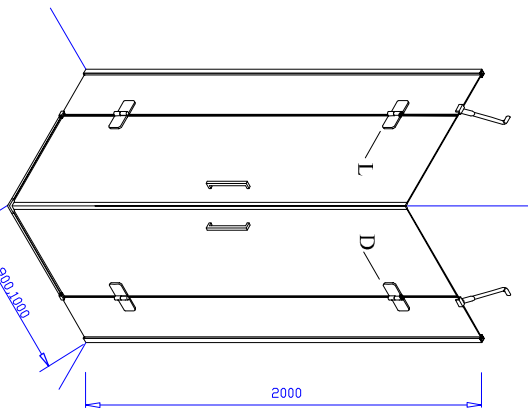
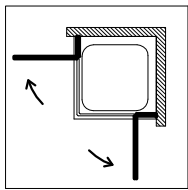
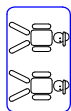
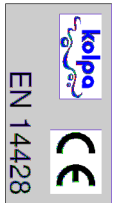
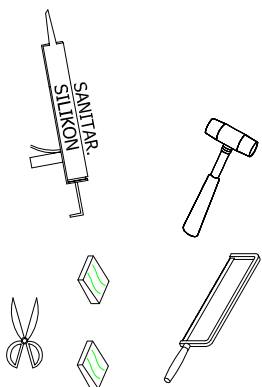
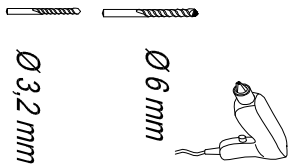
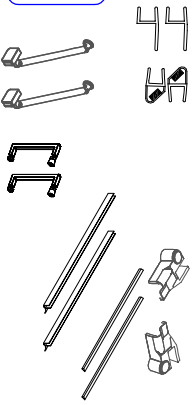

-a-

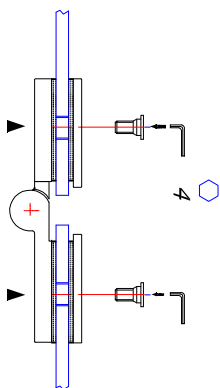
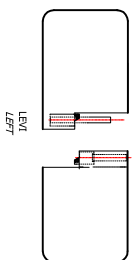
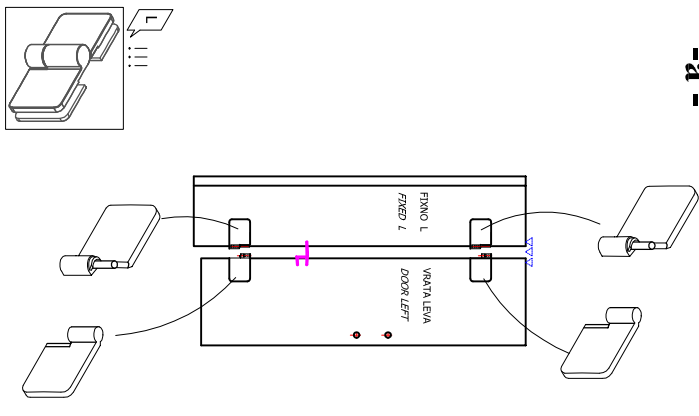

-b-

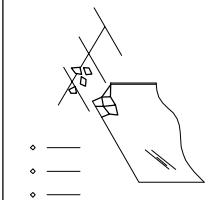
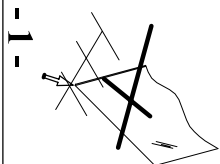
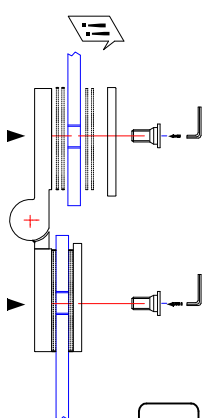
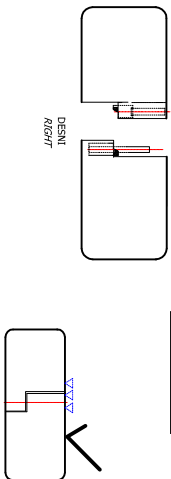
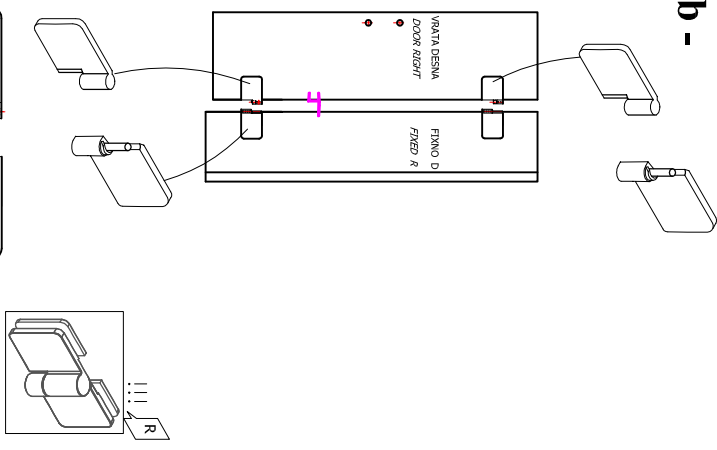

-2-

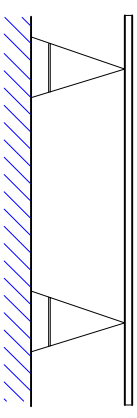

-c-

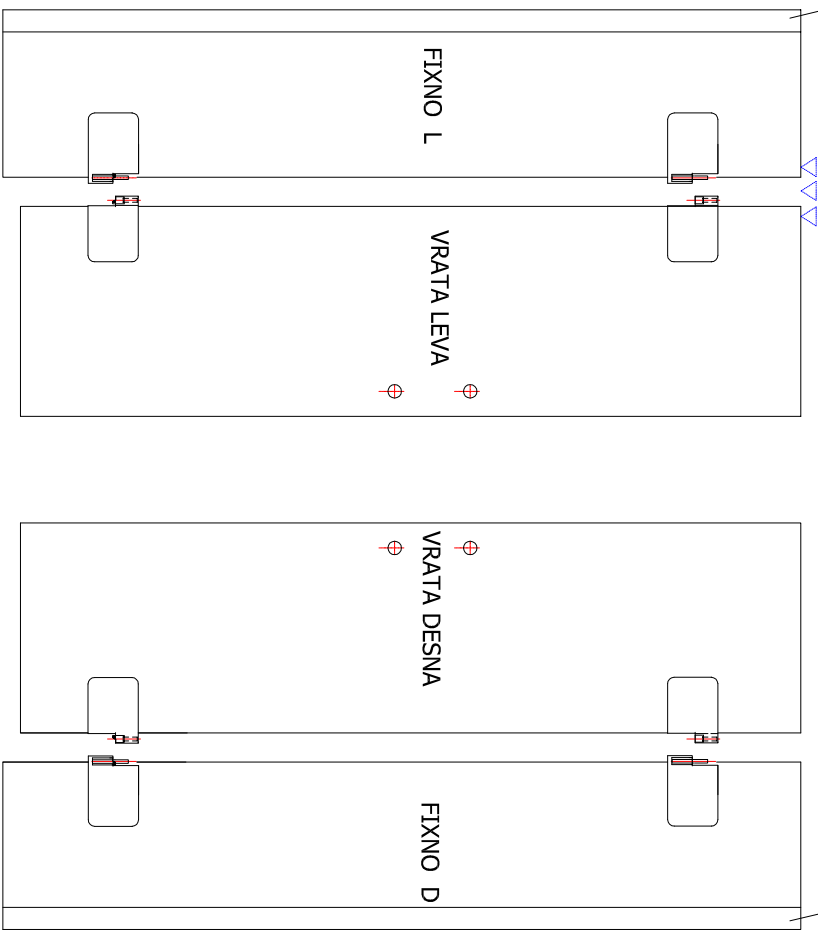
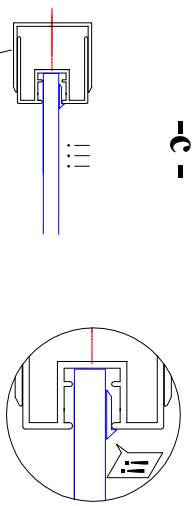

-d-

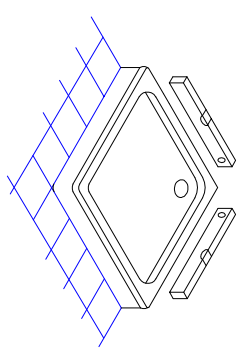

⋮

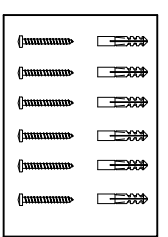

6 X

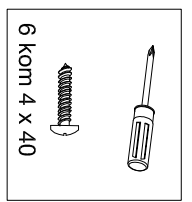

6 kom 4 x 40

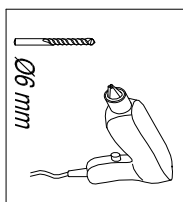

Ø6 mm

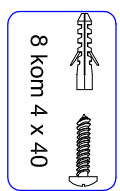
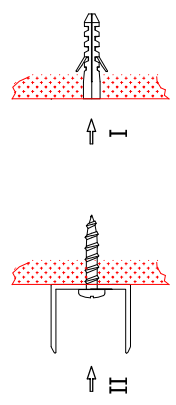

8 kom 4 x 40

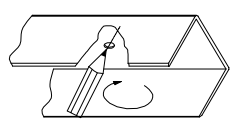

-e-

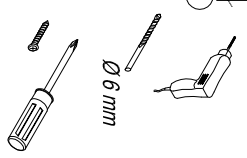
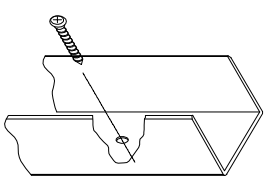

Ø6 mm

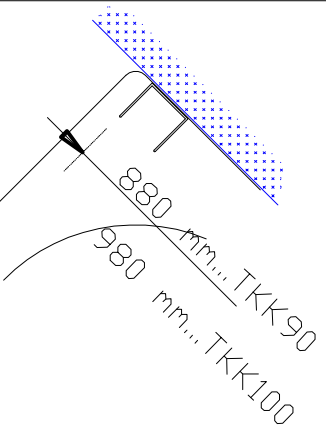

880 mm...TKK90

980 mm...TKK100

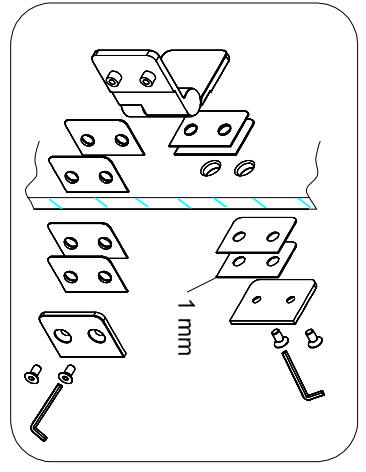

1 mm

-3-

-4-

-f-

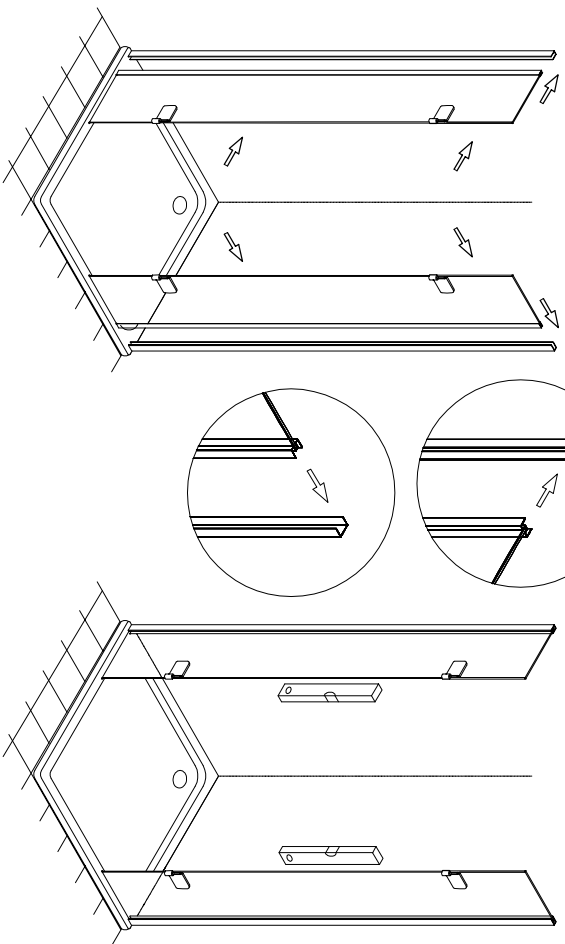

-h-

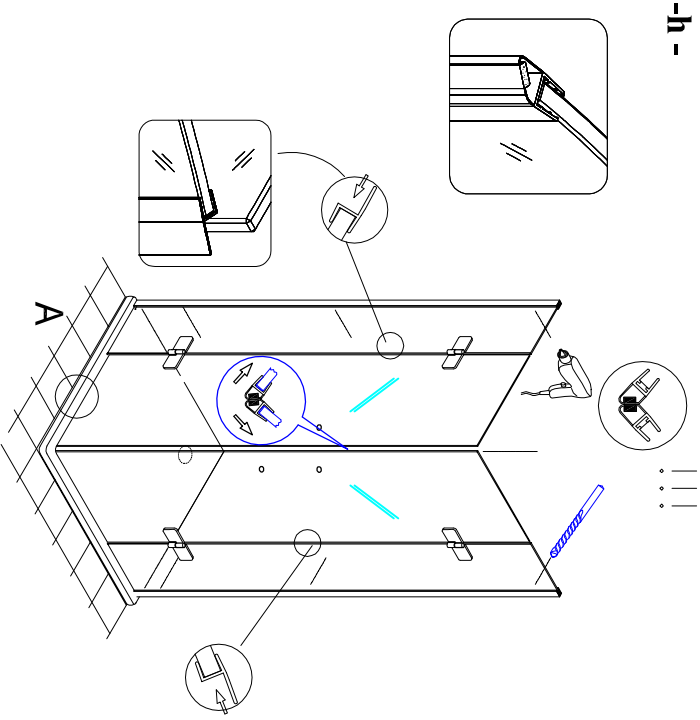

-i-

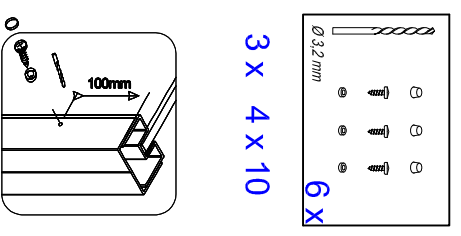

3 X 4 X 10
 6 X
 Ø 3.2 mm

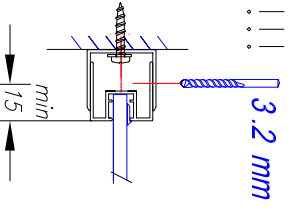

3.2 mm
 min
 15

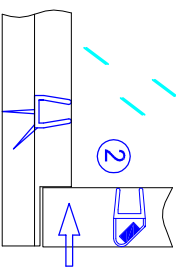

2

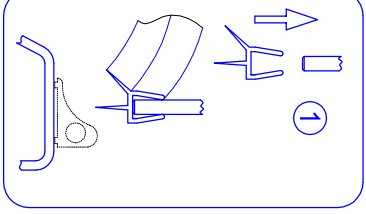

1

-g-

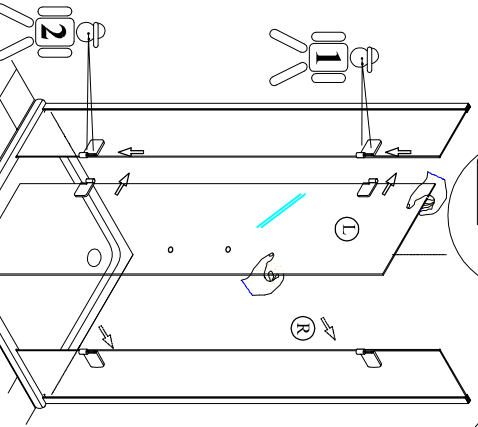
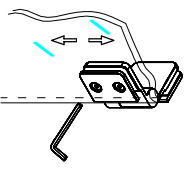
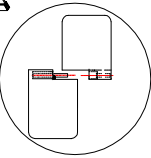
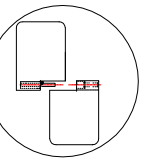

1
 2
 L
 R

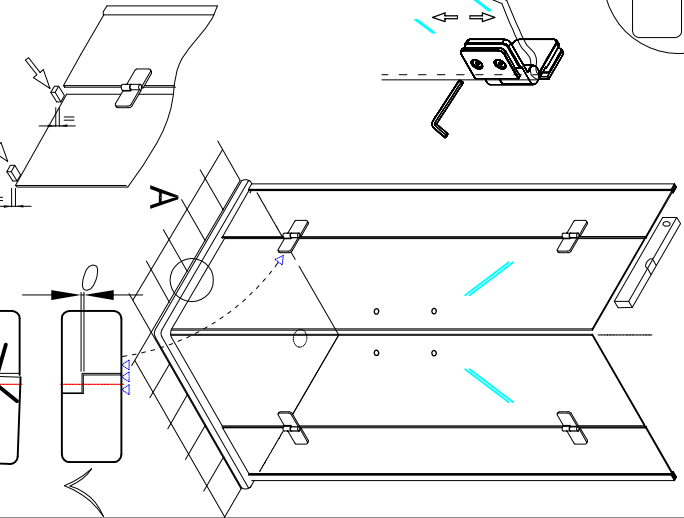

A

-5-

-5-

-6-

L:D

-j-

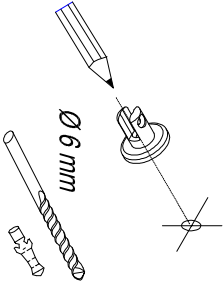
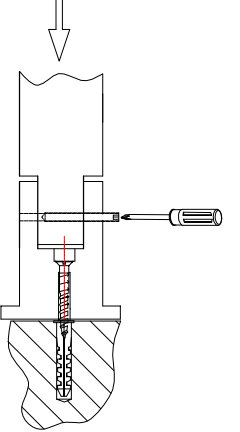
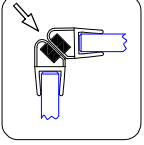
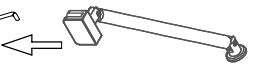
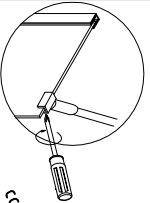
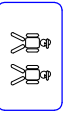

-k-

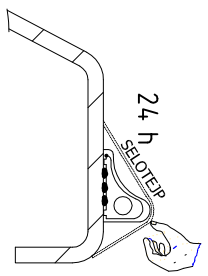
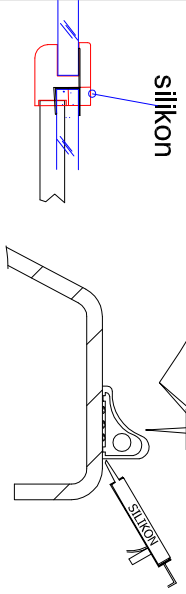
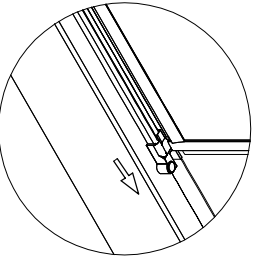
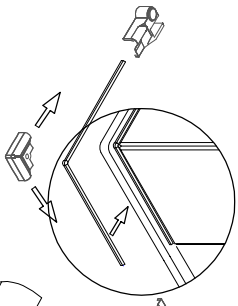

-l-

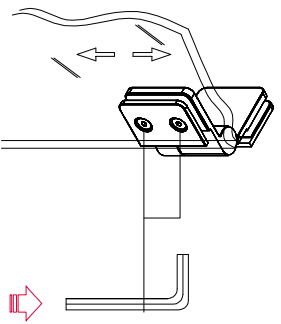

10 Nm

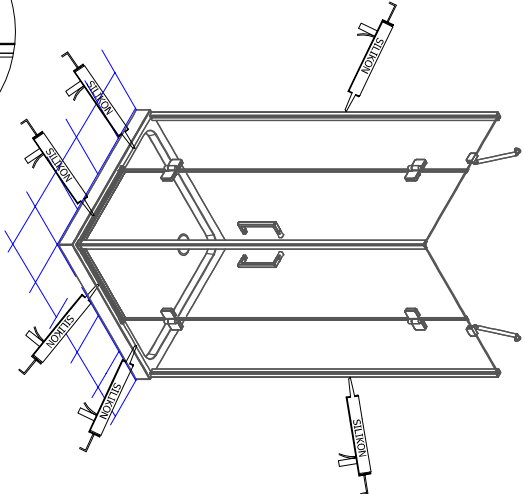
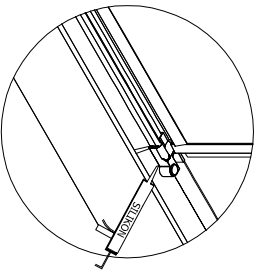
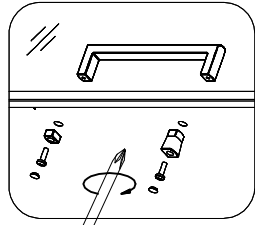
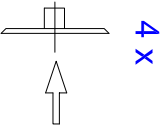

-7-

-8-

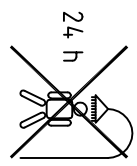

Shema pozicij Assembly Drawing

TKK ATLAS

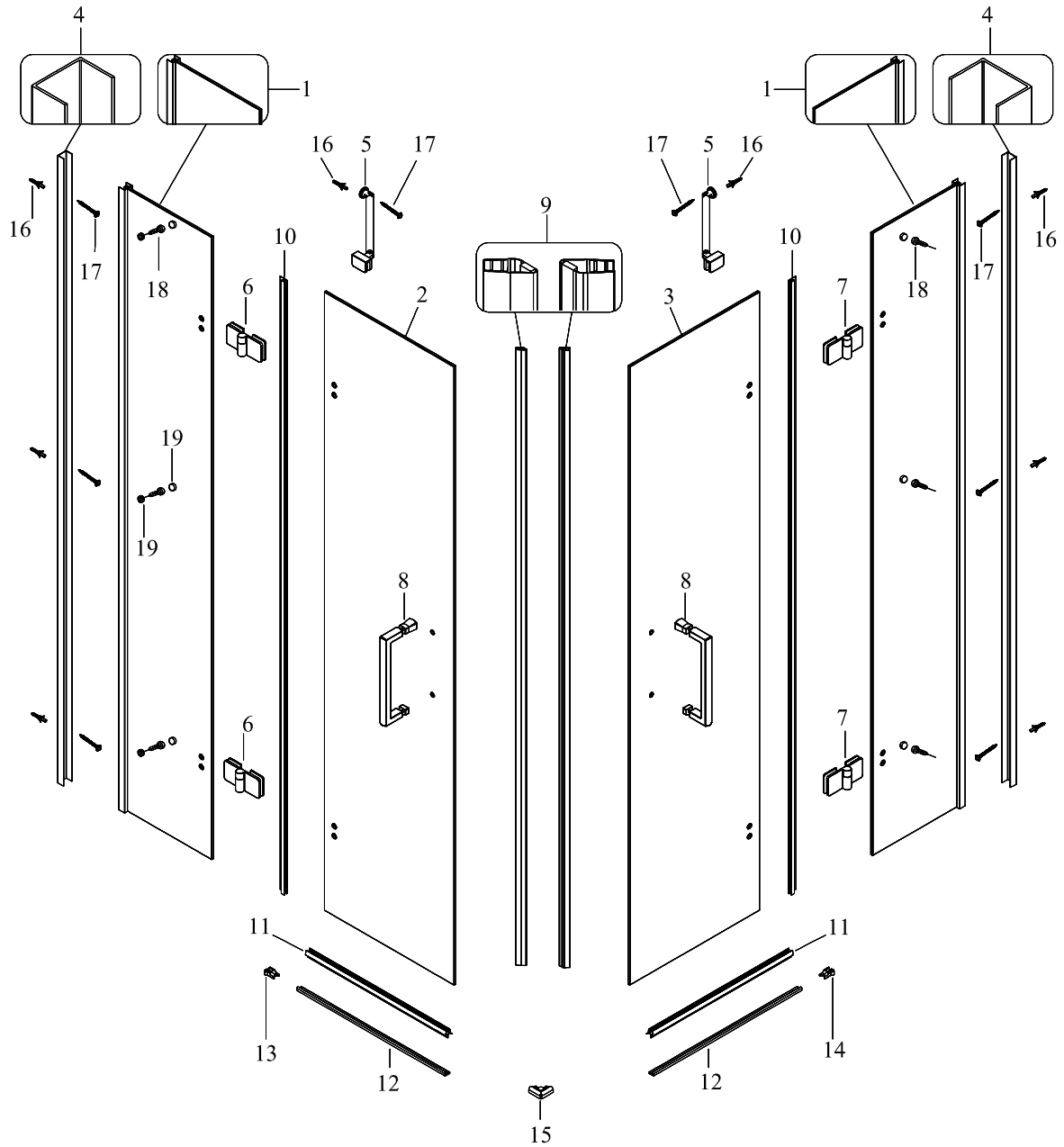

1		x2	2		x1	3		x1	4		x2	5		x2
6		x2	7		x2	8		x2	9		x2	10		x2
11		x2	12		x2	13		x1	14		x1	15		x1
16		x8	17		4x30 x8	18		4x10 x6	19		x6			